



Image for demonstration purposes

  
**Generating Set**  
**SUPERSILENT - Diesel**

## GE.VO.225/205.SS+011

1500 rpm - Threephase - 50Hz - 400V  
 Automatic panel without switching on board



## Standard equipment

### **Canopy Soundproofing**

Removable soundproof canopy  
 Painting canopy (RAL) in galvanized sheet steel  
 Soundproofing with class 1 polyester material  
 Handles with key lock and automatic closing  
 Special baffles for air intake and air expulsion  
 Inspection doors for controls and maintenance

### **Exhaust**

Exhaust rain cap  
 Exhaust manifold protection  
 Insulated exhaust pipes  
 Internal residential muffler - 35dB(A)

### **Fuel Supply**

Single wall daily tank with bunded base  
 Automatic shutdown system for low fuel level  
 Fuel gauge

### **Handling**

Lifting hook integrated into the bearing structure  
 Base frame with anti-overturning forklift pockets

### **Base Frame**

Bunded base at 110% of fuel tank capacity  
 Anti-vibrating mounting pads  
 Battery compartment externally accessible for easy service

### **Engine**

Engine pre-heater 230V  
 High coolant temperature and low oil pressure shutdown system  
 Oil pressure and coolant temperature gauge (only with QPE or +14 variant)  
 External oil drain points  
 Engine liquids (oil and antifreeze)  
 Tropicalized radiator  
 Rotating parts protection  
 Electronic speed governor  
 Radiator level sensor

### **Alternator**

AVR Automatic Voltage Regulator  
 Impregnation for marine environment  
 IP23

### **Panel & connection**

Emergency Stop button  
 Non-Automatic circuit breaker on panel board  
 Tamperproof panel IP55  
 Cable output from side  
 IP44 wiring  
 Start-up battery (pre-charged)  
 Grounding point

### **Documentation**

CE conformity declaration  
 User and Maintenance manual  
 Wirings diagrams

### **Normatives**

All Generating sets are compliant to CE Marking  
 2014/30/UE Electromagnetic compatibility  
 2000/14/CE Noise Emission for outdoor use  
 Factory-designed systems built according to ISO 9001:2015  
 CEI EN 60204-1:2018 - Electrical equipment of machines

## Primary data

### General Information

|                                 |     |         |
|---------------------------------|-----|---------|
| Speed                           | RPM | 1500    |
| Frequency                       | Hz  | 50      |
| PRP                             | KVA | 205     |
| PRP - Prime power               | KW  | 164,0   |
| LTP - Standby power             | KVA | 225     |
| LTP - Standby power             | KW  | 180,0   |
| Standard Voltage                | V   | 400/230 |
| Current                         | A   | 296,24  |
| Voltage for current calculation | V   | 400     |
| COSFI                           | 0,8 | 0,8     |

### General electrical protection

|                                |  |     |
|--------------------------------|--|-----|
| Circuit-breaker rated current  | A  | 320 |
| Type                           | Non-Automatic circuit breaker on panel board |     |
| Circuit-breaker poles          | N  | 4P  |
| Optional/notes circuit-breaker | Opening coil                                 |     |

### Noise level +/- 3dB(A)

|                             |       |    |
|-----------------------------|-------|----|
| LWA                         | dB(A) | 93 |
| Sound pressure level @ 7 mt | dB(A) | 68 |
| Sound pressure level @ 1 mt | dB(A) | 77 |

### Fuel Consumption

| TYPE                          |      | Diesel |
|-------------------------------|------|--------|
| Standard Fuel Tank capacity   | lt   | 400    |
| Autonomy @ 75% load           | h    | 13     |
| Fuel consumption at 100% load | lt/h | 44,3   |
| Fuel consumption at 75% load  | lt/h | 33     |
| Fuel consumption at 50% load  | lt/h | 22,3   |

### General data

|                         |      |       |
|-------------------------|------|-------|
| Rated capacity          | Ah   | 2x120 |
| Auxiliary Voltage       | V    | 24    |
| Exhaust gas temperature | °C   | 510   |
| Exhaust gas flow        | l/s  | 530   |
| Combustion air flow     | l/s  | 191   |
| Cooling fan airflow     | mc/s | 3,1   |
| Exhaust diameter        | mm   | 100   |
| Exhaust side            |      | DX    |

### Weight and Dimensions

|  |            |             |
|--|------------|-------------|
| Dimensions (L x w x h)                             | cm         | 380x120x215 |
| Weight with liquids (excluding optionals and fuel) | Kg (+/-3%) | 2757        |

## ⚙️ Engine

|                        |      |                                       |
|------------------------|------|---------------------------------------|
| Factory                |      | <b>Volvo</b>                          |
| Model                  |      | <b>TAD 733 GE</b>                     |
| Emissions stage        |      | <b>Stage 2</b>                        |
| Speed governor         |      | <b>Electronic</b>                     |
| Radiator               | °C   | <b>50</b>                             |
| Cooling                | Tipo | <b>liquid (water + 50% Paraflu11)</b> |
| Active net power       | Kwm  | <b>175</b>                            |
| Nominal net power      | CV   | <b>237,8</b>                          |
| Cycle                  | Tipo | <b>4 strokes</b>                      |
| Injection              | Tipo | <b>Direct</b>                         |
| Aspiration             | Tipo | <b>Turbo</b>                          |
| Numbers of cylinders   | N    | <b>6</b>                              |
| Cylinders arrangement  |      | <b>L</b>                              |
| Bore                   | mm   | <b>108</b>                            |
| Stroke                 | mm   | <b>130</b>                            |
| Total displacement     | lt   | <b>7,142</b>                          |
| Engine oil features    |      | <b>15W40-API CI-4/CH-4 ACEA E5-E7</b> |
| Total oil capacity     | lt   | <b>34</b>                             |
| Total coolant capacity | lt   | <b>37</b>                             |
| ISO 8528-5 class       |      | <b>G3</b>                             |

## ⚙️ Alternator

**\* May vary based on stock availability. However, a primary brand will be used.**

|                                      |       |                              |
|--------------------------------------|-------|------------------------------|
| Factory                              |       | <b>Stamford</b>              |
| Model                                |       | <b>UCI274H</b>               |
| Single-phase Range                   | KVA   | <b>200</b>                   |
| Voltage Regulator (voltage accuracy) | +/- % | <b>1</b>                     |
| Poles                                | N°    | <b>4</b>                     |
| Phases                               | N°    | <b>3+N</b>                   |
| Standard windings connection         |       | <b>Star Series</b>           |
| Stator/rotor impregnation            |       | <b>H (Outdoor Temp 40°C)</b> |
| Efficiency                           | %     | <b>93,3</b>                  |
| Engine coupling                      |       | <b>Elastic disk</b>          |
| Short circuit current                |       | <b>&gt;= 300% (3In)</b>      |
| Protection degree                    | IP    | <b>23</b>                    |
| Cooling system                       |       | <b>Self ventilating</b>      |
| Maxium overspeed                     | rpm   | <b>2250</b>                  |
| Waveform distortion                  | %     | <b>&lt;5</b>                 |
| Exciter                              |       | <b>Diode bridge</b>          |

## ⚙️ Standard operating environmental conditions

|                     |    |             |
|---------------------|----|-------------|
| Ambient temperature | °C | <b>25</b>   |
| Relative Humidity   | %  | <b>30</b>   |
| Max altitude        | mt | <b>1000</b> |

# Control Systems on board QPE-C-SC-3F-4P-400-O3

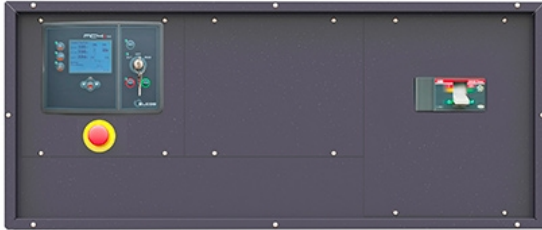

operating scheme - schema di funzionamento

## QPE Automatic panel without switching on board

The QPE-C control panel represents the evolution of the panel for the control and management of the gen set. With its microprocessor logic it is able to meet any user requested features. The dual operation mode manual and automatic guarantees to every type of functionality protection, analysis and control of the generating set in order to make the management easy and efficient. Variant without transfer switch on board. ATS panel type QC as optional. The panel manages the QC panels directly or any other ATS panel.

### Mechanical features

|                   |    |    |
|-------------------|----|----|
| Protection degree | IP | 55 |
|-------------------|----|----|

### Battery charger

|                                |                 |             |
|--------------------------------|-----------------|-------------|
| Model                          |                 | ELCOS - CB1 |
| Maximum output current         | A               | 2,5         |
| Output DC voltage (selectable) | V <sub>dc</sub> | 12-24       |
| Input AC voltage (selectable)  | V <sub>ac</sub> | 220-260     |
| Frequency                      | Hz              | 50-60       |

### Data Communication

|                        |  |                 |
|------------------------|--|-----------------|
| Data connection port   |  | RS-485          |
| Communication protocol |  | Mod-bus RTU-8N1 |

### Remotable functions in terminal box

|  |  |
|--|--|
| GS start   | GS lock                                |
| Genset contactor close/open command (1)              | Mains contactor close/open command (2) |
| Common Alarm - DC output                             | GS test without load                   |
| GS start with key in OFF position (Only in MRS mode) | Programmable output - Volt free output |

(1) Ready to load function (MRS mode only)(2) AMF mode only

## Control Module



|                |           |
|----------------|-----------|
| Model          | MC4       |
| Operating mode | AMF - MRS |

### Specifics

#### Applications

Emergency to the Mains  
Stand-alone  
Construction site/Rental  
Self-production

#### ENGINE MEASURES

Fuel tank level %  
Engine oil pressure BAR (1)  
Engine Coolant temperature °C (1)  
Total run time  
Partial run time  
Hours to maintenance  
Battery voltage  
Battery charging voltage  
Start-ups counter  
Engine speed (2)  
Engine Oil temperature (2)  
Cooler temperature (2)  
Engine oil level (2)  
Engine coolant level (2)  
Engine coolant pressure (2)  
Turbo pressure (2)  
Fuel Consumption (2)  
Tank autonomy - hrs (5)  
Fuel remaining quantity (5)  
Fuel used quantity (5)

#### ALTERNATOR MEASURES

Generator Voltage L1, L2, L3  
Generator Voltage L1-N, L2-N, L3-N  
Generator frequency  
Generator current L1, L2, L3  
Generator Apparent Power kVA  
Generator Active Power kW  
Generator Reactive Power kVAR  
Generator accumulated power kWh  
Power factor Cosfi

#### MAINS MEASURES

Mains voltage L1, L2, L3  
Mains voltage L1-N, L2-N, L3-N  
Mains frequency

#### COMMUNICATION PORTS

Can-bus port  
RS485 port with Mod-bus RTU communication  
RS232 port for display connection  
USB port for parameters saving and firmware update

#### EQUIPMENT

Microprocessor Logic  
Back-lit display  
Programmable from display  
16 event log  
Multiple display languages  
STOP button  
START button  
TEST button  
Reset alarm button  
Alarm mute button  
Fuel transfer pump activation button  
Glow-plug activation button

#### PRE-ALARMS/ ALARMS

Common Alarm  
Fuel reserve (pre-alarm)  
Low fuel level (alarm)  
Tank overflow  
Charge alternator failed (dinamo)  
Low oil pressure (pre-alarm) (1)  
Low oil pressure (alarm)  
Oil sensor failed (alarm)  
High coolant temperature (pre-alarm) (1)  
High coolant temperature (alarm)  
Low coolant temperature (pre-alarm)  
Low water level (1)  
Water in fuel (1)  
Battery undervoltage  
Battery overvoltage  
GS failure to start  
GS failure to stop  
Can-bus Failure  
No Can-bus communication  
Genset overload L1, L2, L3 phases  
Genset short circuit  
Genset overvoltage  
Genset undervoltage  
Genset high frequency  
Genset low frequency  
overspeed  
Reverse power  
Earth fault (pre-alarm)  
Earth fault (alarm)  
Block from password  
CAN communication Failed  
Maintenance request  
Emergency button pressed  
Remote emergency active  
Forced stop  
External battery failed  
Fuel theft  
Genset negative phase sequence  
Mains negative phase sequence  
Fuel theft protection

#### VISUALIZATIONS ON CONTROL MODULE/DISPLAY

Pre-alarms  
Alarms  
Engine measures  
Alternator measures  
Mains measures  
Date and time  
Operating mode  
Genset status  
Mains status  
Mains contactor status  
Genset contactor status  
Digital Input and Output status  
Grounding current mA (3)  
Grounding current threshold mA (3)  
Delay time of differential protection (3)  
Glow plugs status

#### CONTROL MODULE FUNCTIONS

Automatic start and stop when the Mains Fails (7)  
Remote Start and Stop  
Remote Start and Stop with key in OFF position  
Manual Start and stop  
Emergency stop button on panel board  
Remote emergency stop  
Remote lock  
Remote test without load  
Remote test on load  
Scheduled start-ups  
MODBUS commands (Start, Stop, Reset, Test)

#### CONTROL MODULE SPECIAL FUNCTIONS (on demand)

Automatic charging of an external battery  
Dummy load (4)  
Load shedding (4)  
Redundant starter motor management  
Fuel monitoring  
GS battery Load test  
Idle mode  
Service phone number indication  
Variable speed Generator  
Master / Slave mode

- (1) Present with the sensor installed on engine
- (2) Present according to the engine equipment and to the ECU type (ECU - Canbus)
- (3) Present only with the residual current device mounted on genset board
- (4) Present with optional expansion modules
- (5) Present with special function activated
- (6) Only with the optional of the automatic fuel refilling system on board
- (7) Only in AMF mode

AAABBB

## OPTIONAL

### Fuel Supply

**O.G-ACO-AT-C3V-02**

External fuel tank connections with 3-way valve for supply from internal or external tank (130/700 kVA)

**O.G-ACO-AT-C3V-AR-02**

Quick coupling connectors with 3-way valve for internal or external fuel tank connection (130/700 kVA)

**O.G-ACO-AT-CI-02**

External tank connections for supply only from external tank (g without tank) GE 130/700

**O.G-ACO-BT-C3800-1200**

1200 Lt Oversized Fuel Tank on board for SS, RB (180/250 kVA)

**O.G-ACO-GA-01**

Mechanical analogue float for internal fuel tank on board

**O.G-ACO-GA-02**

Electrical analogue float to monitor the external refilling point on board

**O.G-ACO-RE-01**

External refilling point for Gen Sets 10/250 kVA, SS, RB versions

**O.G-ACO-RE-SP-01**

External refilling point with warning light for Gen Sets 10/250 kVA, SS, RB versions

**O.G-ACO-SP-01**

Tank leak sensor with signal reported in the QPE control panel

**O.G-ACO-ST-2P**

Double redundant electric pump kit for automatic fuel refilling system

**O.G-ACO-ST-BG-ES1**

"Easy" automatic fuel refilling system on board, controlled by QPE-C and QLE-B panels

**O.G-ACO-ST-BG-HDT**

"Heavy Duty" automatic fuel refilling system on board, controlled by QPE-C and QLE-B panels

**O.G-ACO-ST-BG-STD**

"Standard" automatic fuel refilling system on board, controlled by QPE-C and QLE-B panels

### Alternator

**O.G-ALT-AL-CHBR-03**

Different brand alternator 130/250 kVA (Check dimensions)

**O.G-ALT-AL-COTE-01**

Temperature control unit up to 4 x PT100 probes for MC4 management

**O.G-ALT-ST-ACO-01**

Anti-condensation heater 230 V (on Stamford from 80 to 2000 kVA)

**O.G-ALT-ST-AVR-MX321**

Stamford MX321 automatic voltage regulator with PMG (Check dimensions)



**O.G-ALT-ST-AVR-MX341** Stamford MX341 automatic voltage regulator with PMG (Check dimensions)



**O.G-ALT-ST-PT100-1CU** 1 x PT100 probe on bearing (80/3000 kVA)



**O.G-ALT-ST-PT100-3AV** nr. 3 RTD-PT100 probes on stator windings (80/3000 kVA)



**O.G-ALT-ST-PT100-6AV** nr. 3+3 RTD-PT100 probes on stator windings (80/3000 kVA)



**O.G-ALT-ST-RIGU-01** Diode Failure Detector (DFD) mounted on the alternator. Alarm contact available into the panel

### Batteries



**O.G-BAT-BAE-03** Maintenance free high efficiency starter batteries (130/250 kVA)



**O.G-BAT-DOB-02** Redundant battery kit for Gen Sets 130/250 kVA



**O.G-BAT-STB-02** Battery isolator lockable(130/700 kVA)

### Canopy



**O.G-COF-AM-01** Hinges and Doors with tamper-proof device (10/100 kVA)



**O.G-COF-AP-01** Door opening alarm system (each door)

**O.G-COF-C3800-INOX** Additional cost for stainless steel canopy (C3800)

**O.G-COF-CA-C3800** IP 43 Conveyors for Gen Sets 180/250 kVA - supplied disassembled



**O.G-COF-CH-06** Additional cost for larger canopy C4100 instead of standard C3600 -Dim. cm 410x150x230H - Fuel Tank 600 lt

**O.G-COF-DI-C3800** Double soundproofing -2 dBA at 7 mt. (180/250 kVA) including IP43 conveyors (provided disassembled)

**O.G-COF-DLO-C3800-60KW** Dummy Load 60kW on board for Gen Sets 180/250 kVA



**O.G-COF-EAF-05** Frontal air expulsion for Gen Sets 180/250 kVA (C3600) (change the noise level)



**O.G-COF-FP-02** Door stop (130/1000 kVA)



**O.G-COF-IL-01** Internal LED lighting with micro-switches for Gen Sets 10/250 kVA

**O.G-COF-PV-02**

Lift off doors kit for SS versione (130/400 kVA) and PRO version (130/500 KVA)

**O.G-COF-TRT-MAR-03**

High resistance canopy treatment for corrosive environments for 130/250 kVA (SS, RB Versions)

**O.G-COF-VER-PAR-03**

Canopy custom paint (Grey base-frame) for 130/250 kVA (SS, RB Versions)

**O.G-COF-VER-TOT-03**

Total canopy custom paint for 130/250 kVA (SS, RB Versions)

 **Electrical on board**
**O.G-USP-AR-480**

Powerlock connector 480A on board for SS Version

**O.G-USP-BR-03**

Copper bars for MCCB terminal box extension (130/250 kVA) SS Version

**O.G-USP-MO-03**

Terminal box inside the cable entry compartment for Gen Sets 130/250 kVA SS Version

**O.G-USP-MPRB-03**

RB module with 5 sockets, 1 plug and power cable access for GE from 130 to 250 KVA SS version (check feasibility)

**O.G-USP-SW-MOT.0130-0250**

Motorization switch on board machine, integrated in the panel for 130/250 Kva Ge - (for variant +11)

**O.Q-QBM-BMIN-230V-02**

Additional price for 230V minimum voltage coil on MCCB both on the control panel and on the alternator (check feasibility)

**O.Q-QBM-CPI-BEN-01**

Permanent insulation controller for IT networks up to 230V / 400V. BENDER IR423-D4-1. Adjustable threshold 10 ÷ 300 kohm. (2 DIN rail modules - check feasibility)

**O.Q-QLE-K-DIF-M3**

Adjustable differential protection only for MC2-PLUS controller for Gen Sets 10/500 kVA (+011 variant)

**O.Q-QPA-COM-GC200**

Option with COMAP GC200 controller on board instead of DSE 8610.

**O.Q-QPA-COM-GC500**

Option with COMAP GC500 controller on board instead of DSE 8610.

**O.Q-QPA-COM-INTEL**

Option with COMAP INTELIGEN controller on board instead of DSE 8610.

**O.Q-QPA-LOV-RGK900**

Option with LOVATO RGK900 controller on board instead of DSE 8610.

**O.Q-QPE-485.CONV-LAN**

Converter 485/LAN for QPE-C, QLE-B panel

















**O.Q-QPE-485.CONV-USB**

Converter 485/USB for QPE panel

**O.Q-QPE-DIS-MS.01**

MASTER/SLAVE device for QPE panel



|   |                              |   |
|---|------------------------------|---|
|   | <b>O.Q-QPE-INT-CST-03</b>    | STATUS contact GE main switch wired to terminal board inside the QPE panel (130 / 250KVA) on board the GENERATOR. |
|   | <b>O.Q-QPE-K-DIF</b>         | Differential protection adjustable for the MC4  |
|   | <b>O.Q-QPE-MD-QPE-C</b>      | GSM remote management modem for QPE panel   |
|                  | <b>O.Q-QPE-POT-VOLT</b>      | Internal potentiometer for voltage regulation - available only for variant +10/+11                                |
|                  | <b>O.Q-QPE-PR-QPE-C</b>      | Remote panel for QPE-C, QLE-B - available only for variant +10/+11  |
|                  | <b>O.Q-QPE-QBM-COM-AMF25</b> | Option with QBM COMAP AMF25 controller on board instead of QPE  |
|                  | <b>O.Q-QPE-QBM-DSE-7320</b>  | Option with QBM DSE7320 controller on board instead of QPE.   |
|                  | <b>O.Q-QPE-RIL-16RELE</b>    | 16-relay module for QPE panel   |
|                 | <b>O.Q-QPE-RX8-QPE-C</b>     | Start-stop radio control with max. radius 500 mt indoors and 5 km outdoors (for QPE panel).                       |
|                | <b>O.Q-QPE-SAS-02</b>        | Auto Start-Stop at load request (QPE, QLE panels)   |
|                | <b>O.Q-QPE-SCD-01</b>        | Anti-condensation heater inside the panel   |
|                | <b>O.Q-QPE-SEL-50-60</b>     | Switch selector 50Hz 400V / 60Hz 480V   |
|                | <b>O.Q-QPE-TG-EVO-GPS-2G</b> | Remote management system via LAN/GSM 2G with WEB application and GPS location system                              |
|                | <b>O.Q-QPE-TG-EVO-GPS-3G</b> | Remote management system via LAN/GSM 3G with WEB application and GPS location system                              |
|                | <b>O.Q-QPE-TG-QPE-C</b>      | Remote management software via LAN for QPE-C, QLE-B panel compatible with Windows XP and 7                        |
|  <b>Engine</b> |                              |   |
|                | <b>O.G-MOT-FC-6</b>          | Dust collector filter - for Gen Sets 180/250 kVA  |
|                | <b>O.G-MOT-FSA-6</b>         | Fuel/Water Separator Filter - for Gen Sets 180/250 kVA  |
|                | <b>O.G-MOT-K-40C-03</b>      | Engine liquids suitable for -40°C ambient temperature for Gen Sets 130/250 kVA                                    |

**O.G-MOT-MAG-02**

Dual starter motor for Gen Sets 180/250 kVA (engine configuration to be checked)

**O.G-MOT-PO-02**

Oil change pump for Gen Sets 130/700 kVA

**O.G-MOT-RF-02**

Electronic speed governor for Gen Sets 50/200 kVA

**O.G-MOT-SC-AC-EL-03**

Super hot engine heater 230V with thermostat on board for Gen Sets 130/250 kVA

**O.G-MOT-SC-AC-WE-02**

Webasto diesel-operated water pre-heater (130/400 kVA)

**O.G-MOT-SE-LR-02**

Radiator coolant level sensor from 130 to 700 kVA

**O.G-MOT-SRO-AU-30L**

Automatic oil refilling system (130/250 kVA)

 **Handling**
**O.G-MOV-CN-5**

Off-road trailer with 2 pneumatic wheels and tow bar (SS, RB Gen Sets 130/250 kVA)

**O.G-MOV-CO-ST-05**

Roadworthy trailer 80km/h (180/250 kVA), registration excluded.

**O.G-MOV-GC-BIG-01**

Increased central lifting hook with 10x5cm hole (10/250 kVA SS version)

**O.G-MOV-KRM-SS-03**

Reinforcement kit for mobile installation (dedicated trailers or wheeled machinery) SS Version from 130 to 250 kVA

 **ATS Panels**

**QC2.0400A**

Separate ATS panel, ABB 400A motorized change-over (275 kVA 400V - 160 kVA 230V) Dim. 60 x 50 x 160 cm - 109 kg. (ex QC2.275)

**QCP2.0400A**

Separate ATS switching panel, with Lovato ATL 610 control unit, for variant +014, ABB motorized change-over 400A 4P (275kva 400V) and compartment for power cables inlet

**QLTS.400A**

Wall-mounted ATS switching panel 400A 4P (275 kVA 400V) Dim. 80 x 28 x 60 cm - 40 kg.

 **Exhaust**

**O.G-SCA-CAT-05**

Catalytic converter (130/250 kVA)

**O.G-SCA-FAP-K200**

Particulate filter (DPF) for Gen Sets 180/200 kVA



**O.G-SCA-GF-80**

Exhaust bellow with flexible joint including flange and counter flange (50/250 kVA)



**O.G-SCA-PF-03**

Spark arrester for Gen Sets 130/250 kVA

**Test**



**MS.CP-LT-02**

FAT - Factory Acceptance Test for single Gen Set from 130 to 400 kVA according to our standard procedures in Elcos factory (max 2 hours - max 4 people - max 1 hour of operation)



**MS.CP-SP-02**

FAT - Factory Acceptance Test for single custom Gen Set from 130 to 400 kVA max 4 operating hours or parallel system up to 4 units for 1 operating hour, in Elcos factory (max 4 hours - max 4 people )



**MS.CP-ST-02**

FAT - Factory Acceptance Test for single Gen Set from 130 to 400 kVA according to our standard procedures in Elcos factory (max 4 hours - max 4 people - max 2 hour of operation)



**MS.RF-ST-01**

Noise test report for single Gen Set from 10 to 250 kVA



**MS.TV-ST-01**

Vibration test on 10 points with certificate for single Gen Set from 10 to 250 kVA

**Vari**



**O.G-VAR-CAT-02**

Toolbox for ordinary maintenance.

**O.G-VAR-PUN-TER-01**

Round earth spike, diam. 20 mm, height 1.5mt, galvanized, complete with clamp and 3m yellow/green cable model FS17 1x35mm<sup>2</sup> with cable lugs.

**O.G-VAR-PUN-TER-02**

Cross-shaped earth spike, height 1.5mt, galvanized, complete with clamp and 3m yellow/green cable model FS17 1x35mm<sup>2</sup> with cable lugs.



**O.G-VAR-TPD-01**

IP 55 document holder

**PRP**

Engines of this rating provide unlimited hours of usage in a variable load application. The average load factor should not exceed 70% of the engine's prime power rating with a maximum number of 500 operational hours at 100% prime power rating. An overload capability of 10% is available, however, is limited to a period of 1 in every 12 hours

**LTP**

Limited-time running power is defined as the maximum power available, under the agreed operating conditions, for which the generating set is capable of delivering for up to 500h of operation per year with the maintenance intervals. The overload is not allowed.

|        |        |              |               |       |          |      |    |              |            |          |
|--------|--------|--------------|---------------|-------|----------|------|----|--------------|------------|----------|
| Sheet: | C 3800 | SUPER SILENT | Exhaust side: | Type: | STANDARD | Rev: | 02 | Last Update: | 22-05-2020 | Page 1/2 |
|--------|--------|--------------|---------------|-------|----------|------|----|--------------|------------|----------|

**OVERALL DIMENSIONS [mm]**

REAR VIEW

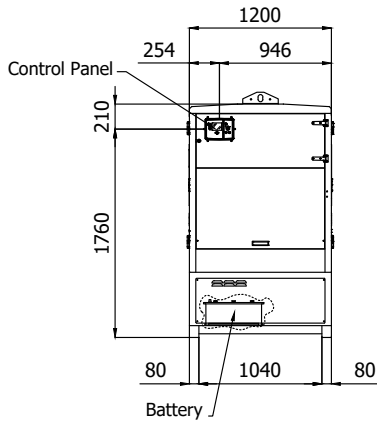

LEFT SIDE VIEW

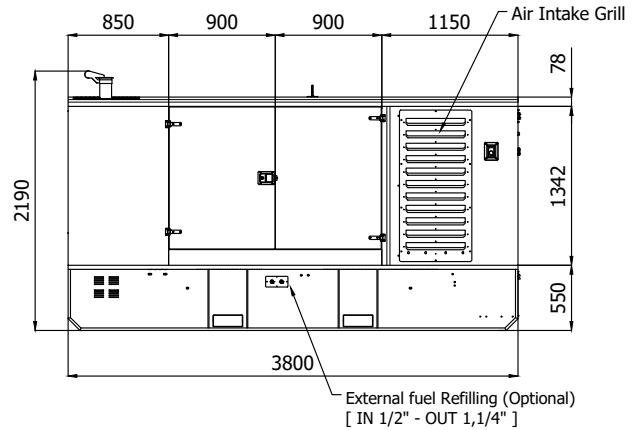

FRONT VIEW

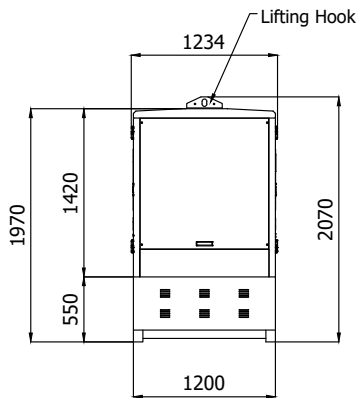

RIGHT SIDE VIEW

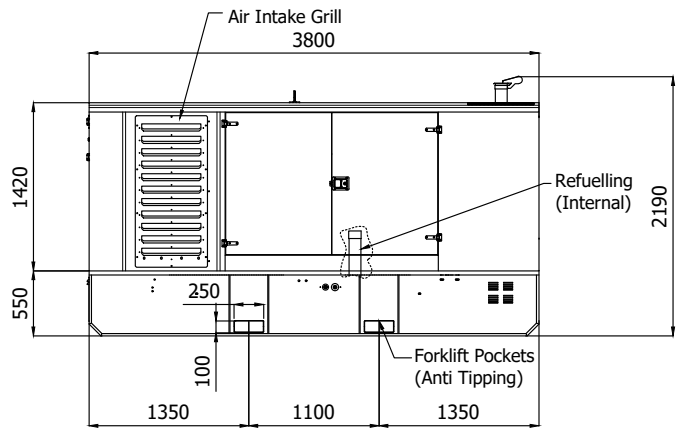

TOP VIEW

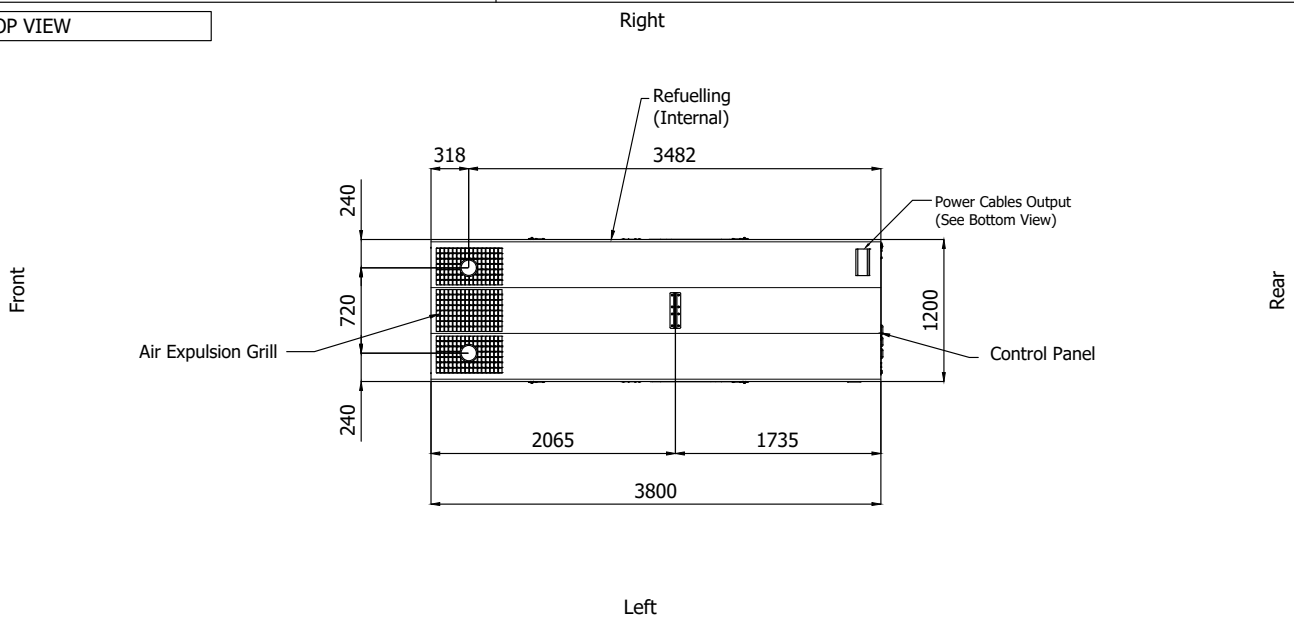

**IMPORTANT:**

- 1) Form and dimension refer to the generating set on catalogue
- 2) Form and dimension are subject to change in order to update or improve the products
- 3) This document can not be copied or transmitted without ELCOS S.r.l. approval

|        |        |              |               |       |          |      |    |              |            |          |
|--------|--------|--------------|---------------|-------|----------|------|----|--------------|------------|----------|
| Sheet: | C 3800 | SUPER SILENT | Exhaust side: | Type: | STANDARD | Rev: | 02 | Last Update: | 22-05-2020 | Page 2/2 |
|--------|--------|--------------|---------------|-------|----------|------|----|--------------|------------|----------|

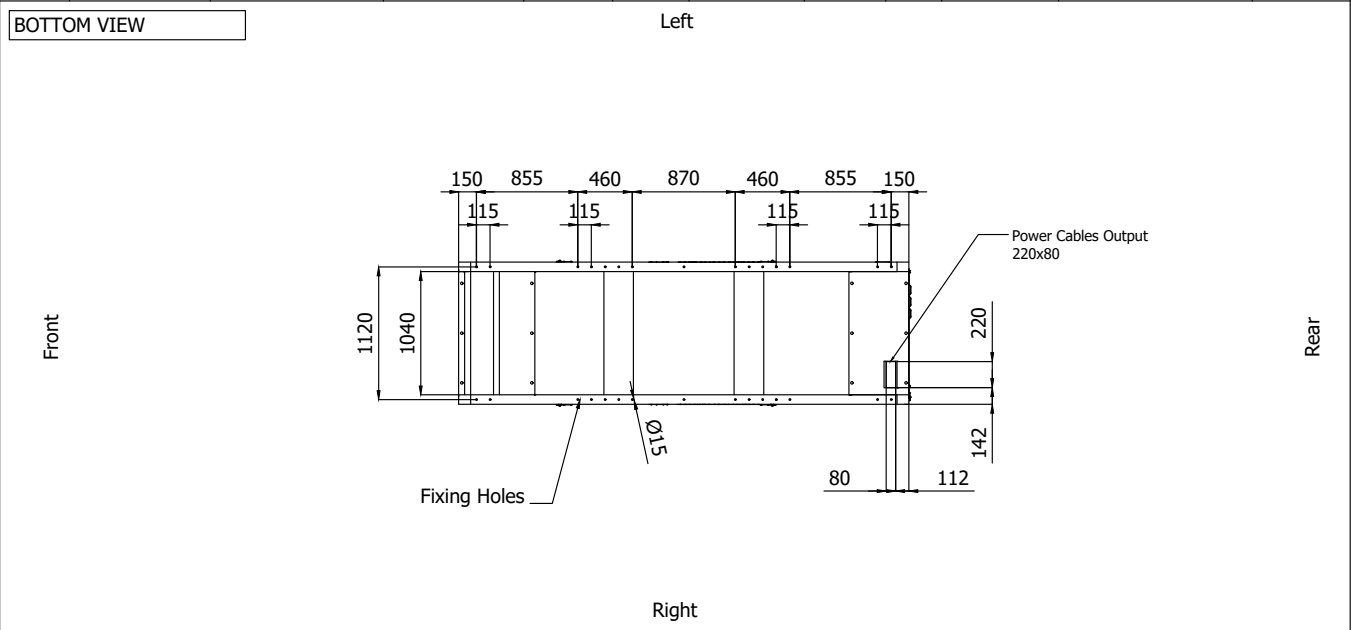

**DIMENSIONS WITH OPEN DOORS [mm]**

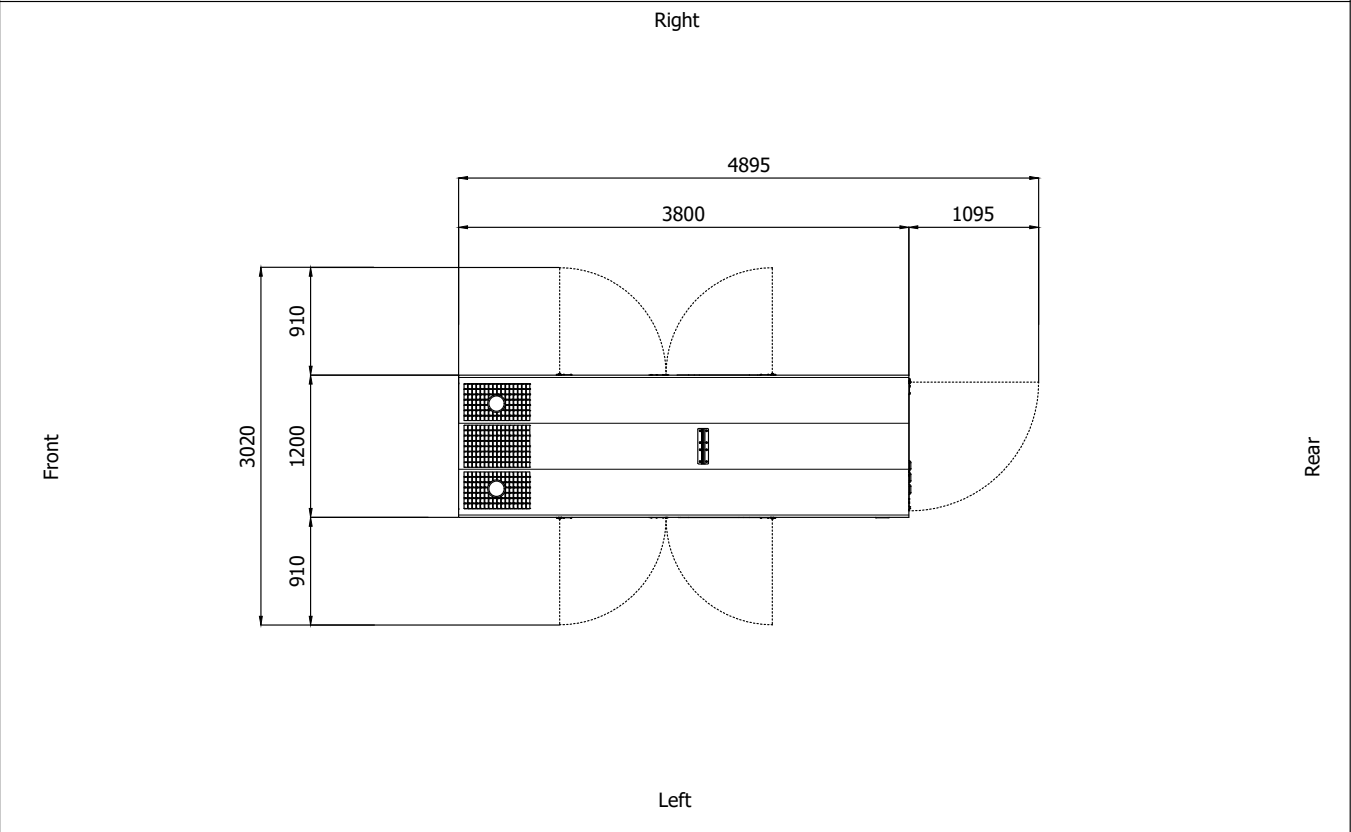

Note: With Lifting-Off Door Solution consider only canopy dimensions.  
(Models with "Control Panel" behind rear door will mount a special cover to protect it)

**VENTILATION OF THE ROOM**

The windows area in the generating set room needs to be (recommended):  
 Aspiration: 1.35 m<sup>2</sup>  
 Expulsion: 0.90 m<sup>2</sup>  
 ATTENTION: for a correct ventilation the expulsion air and the exhaust gas needs to be conveyed in the open-air

**IMPORTANT:**

- 1) Form and dimension refer to the generating set on catalogue
- 2) Form and dimension are subject to change in order to update or improve the products
- 3) This document can not be copied or transmitted without ELCOS S.r.l. approval

Data and technical specifications are subject to change in order to update or improve the products.